

KOBELCO

SK850_{LC}

■ Bucket Capacity:

2.3 - 5.4 m³

■ Engine Power:

380 kW / 1,800 min⁻¹

■ Operating Weight:

80,200 kg - 86,600 kg



We Save You Fuel
Achieving a Low-Carbon Society



KOBELCO

SK850_{LC}

Higher fuel
efficiency
means
"Efficiency"

Increase in
productivity
means
"Power"

To urban centres, and to mines around the world. Kobelco's all-out innovation brings you durable earth-friendly construction machinery that's equal to any task, at sites all over the planet. Increased power and even greater fuel economy bring higher efficiency to any project. Kobelco SK850LC machines are also more durable than ever, able to withstand the rigors of the toughest job sites. It all adds up to new levels of value that are a step ahead of the times. Also, this machine conforms to Stage V Exhaust Emission Standards, thanks to its significantly reduced NOx* emissions. While focusing on the global environment of the future, Kobelco offers next-generation productivity to meet the need for lower life cycle costs and exceed the expectations of customers the world over.

* NOx: Nitrogen Oxide



Evolution Continues, with Improved Fuel Efficiency

Hydraulic System: Revolutionary Technology Saves Fuel

Hydraulic Circuit Reduces Energy Loss

We have made every effort to enhance fuel efficiency by minimizing hydraulic pressure resistance, improving the hydraulic line layout to control friction resistance loss and minimizing valve resistance.

Improved hydraulic piping is an effective means of reducing pressure loss.

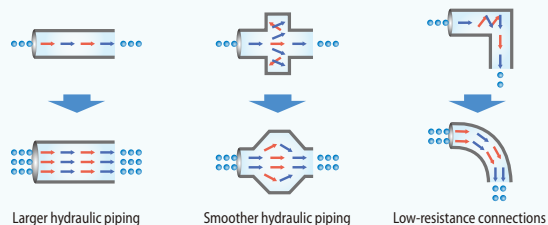

Revolutionary technology boosts efficiency and minimizes fuel consumption

Operation Mode

■ Optimal operation with three modes

- H** **H-mode** Maximum power for maximum productivity on your toughest jobs
- S** **S-mode** Ideal balance of productivity and fuel efficiency for a range of urban engineering projects
- E** **ECO-mode** ... Minimum fuel consumption for utility projects and other work that demands precision

Improved fuel economy in ECO-modes

■ Compared to previous models (SK850LC-1)

- E** **ECO-mode** ... About **17%** improvement

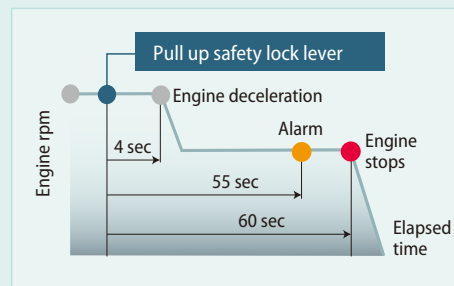

AIS (Auto Idle Stop)

If the boarding/disembarking lever is left up, the engine will stop automatically. This eliminates wasteful idling during standby, saving fuel and reducing CO₂ emissions as well.

Higher fuel efficiency means "Efficiency"

The new arm interflow system more efficiently controls hydraulic fluid flow, and significant reduction of in-line resistance and pressure loss boosts fuel efficiency.

The engine, already well-known for its environmental performance has a new SCR* system, and its reduced NOx emissions means the engine now meets Stage V Standards.

* SCR: Selective Catalytic Reduction

Built to operate in tough working environment

Hydraulic Drive for Engine Cooling Fan, Independent Oil Cooler Fan

Hydraulic drive optimizes the cooling fan rotation speed to improve fuel economy and reduce noise. Also, the independent oil cooler fan better matches cooling to the hydraulic oil temperature, for optimal oil temperature control.

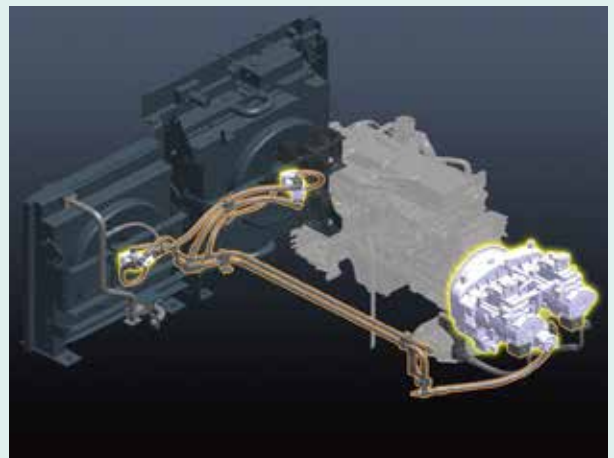

Conforms to Stage V exhaust emissions standards

Next-Generation Electronic Engine Control

The new electronic-control common-rail engine features high-pressure fuel injection and multiple injection with improved precision. It is fitted with an EGR cooler, and DP filter which deliver high output from optimized combustion and greatly reduce PM and NOx emissions.

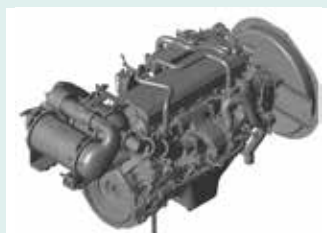

VG Turbo Reduces PM

The variable-geometry turbocharger adjusts air intake to maximize combustion efficiency. At low engine speeds the nozzles are closed, the turbo speed increased and air intake is boosted. This helps lower fuel consumption.

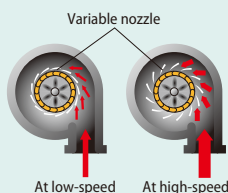

SCR System with DEF/Urea NEW

Engine exhaust system utilizes Selective Catalytic Reduction (SCR) to convert NOx* into harmless nitrogen and water emissions. SCR combined with a Diesel Particulate Filter (DPF) makes a much cleaner machine meeting StageV exhaust emission standards.

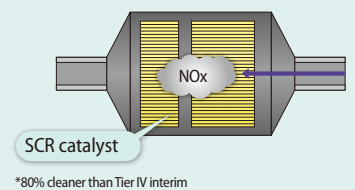

EGR Cooler Reduces NOx

Cooled exhaust gases from the EGR cooler are mixed with fresh air in the intake. The recirculated air lowers the combustion temperature which reduces NOx.

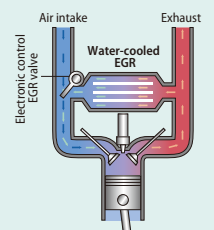

More Power and Higher Efficiency

The highly efficient hydraulic system minimizes fuel consumption while maximizing power. With nimble movement and ample digging power, this excavator promises to improve your job productivity.

Superior Digging Force

■ Max. Bucket Digging Force

432kN

■ Max. Arm Crowding Force

351kN



Get More Done Faster with Superior Operability

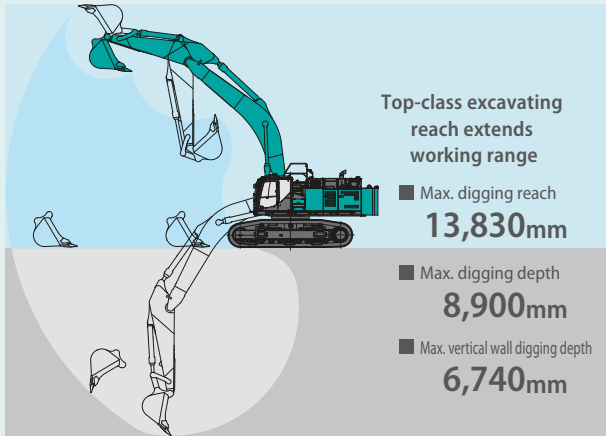

Top-class excavating reach extends working range

- Max. digging reach **13,830mm**
- Max. digging depth **8,900mm**
- Max. vertical wall digging depth **6,740mm**

Values are for HD arm (3.6 m)

Top Class Traveling Force

Powerful traveling force and pulling force deliver plenty of speed when climbing slopes or negotiating bad roads, and the agility to change direction swiftly and smoothly.



■ Drawbar Pulling Force: **653kN**

Piping for Quick Hitch



A quick hitch hydraulic line, which speeds up attachment changes, is available as a standard.

A Light Touch on the Lever Means Smoother, Less Tiring Work

NEW



Smooth and light operation lever reduces fatigue over long working hours or continued operations.

MVLC Width

Crawler width can be adjusted by fixing bolt positions to comply with transport regulations.

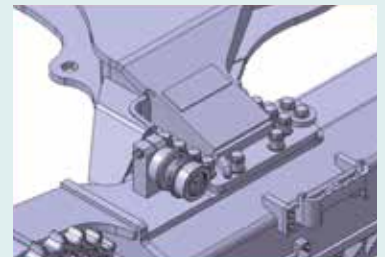

Operator-friendly Features Include Controls that Are Easy to See, Easy to Use



Multi-Display in Color

Brilliant colors and graphic displays are easy to recognize on the LCD multi-display in the console. The display shows fuel consumption, maintenance intervals, and more.

- 1 Analogue gauge provides an intuitive reading of fuel level and engine water temperature
- 2 Green indicator light shows low fuel consumption during operation
- 3 PM accumulation display (left)/Urea level gauge (right)
- 4 Fuel consumption/Switch indicator for rear camera images
- 5 Digging mode switch
- 6 Monitor display switch

One-Touch Attachment Mode Switch

A simple flick of a switch converts the hydraulic circuit and flow amount to match attachment changes. Icons help the operator to confirm the proper configuration at a glance.



PM accumulation/
Urea accumulation display

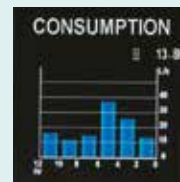

Fuel consumption



Maintenance

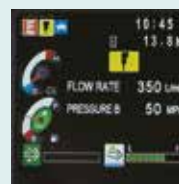

Breaker mode

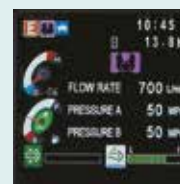

Nibbler mode

Increased Power with Enhanced Durability to Maintain the Machine's Value

Smart system design increases strength and eliminates hydraulic problems. Enhanced POWER, reliability, and durability takes productivity to a new level.

Improved filtration system reliability

Clean, contaminant-free fuel and hydraulic fluid are essential to stable performance. The improved filtration systems reduce the risk of mechanical trouble and enhance longevity and durability.

Hydraulic Fluid Filter ^{NEW}

Recognized as the best in the industry, our super-fine filter separates out even the smallest particles. A new cover prevents contamination when changing filters.

Long-life
hydraulic fluid:
5,000
hours

Hydraulic
fluid filter
replacement
cycle is
1,000
hours



Hydraulic Fluid Filter Restriction Indicator ^{NEW}

Pressure sensors at the inlet and outlet of the hydraulic oil filter monitor pressure difference to assess the degree of clogging. If the pressure difference exceeds a set level, a warning appears on the multi-display, so the filter can be cleaned before contamination reaches the hydraulic oil tank.

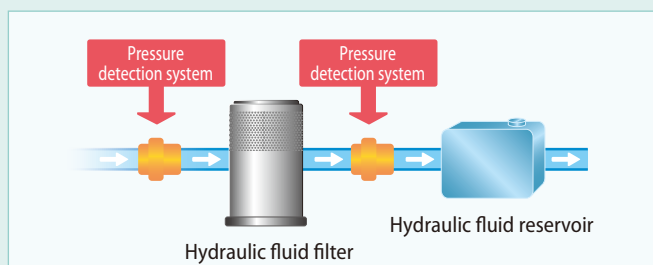

Easy grease refill

Newly designed side door and catwalk are installed to right side body. Thanks to the door and catwalk, refill of grease become easier.

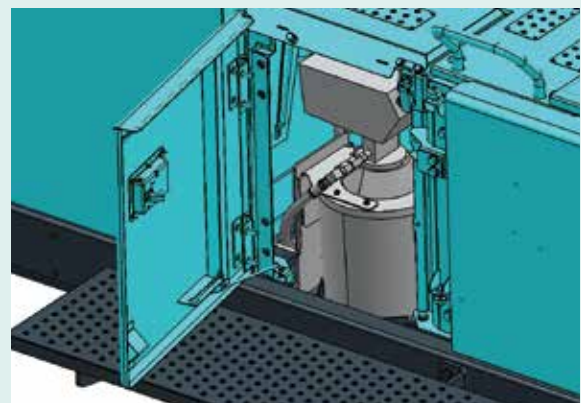

Access door for grease gun

Access door to auto grease gun is set to front deck. The access door enables to access to auto grease gun from ground level.





500 Hour Attachment Lubrication Interval

Self-lubricating bushings are used at the attachment pins and the bushings with high abrasion resistance are used on the pins around the bucket. The lubrication cycle of the lubrication points around the bucket is 250 hours and that of other lubrication points is 500 hours.



* Additionally, the two-piece bucket bushings protect the side of the arm from contact and then wear from the bucket ears. Should the bucket bushings need replacement, they can be replaced separately from the larger main bushing, reducing costs.

Three Track Guides

Three heavy-duty track guides installed on each crawler side frame assure stability in the most demanding situations.



Full Track Guides (Option)

Optional full track guides withstand powerful vibrations and eliminate de-track concern.



Protective Lower Undercover

The undercover attached to the lower frame protects the hydraulic piping and equipment from flying rocks, bits of rebar, and other debris.



Comfortable Cab Is Now Safer than Ever

A work environment that is quieter and more comfortable. A cab that puts the operator first is key to improved safety.



Comfort

Super-Airtight Cab



The high level of air-tightness keeps dust out of the cab.

Quiet Inside

The high level of air-tightness ensures a quiet, comfortable cabin interior.

Low Vibration

Coil springs absorb small vibrations, and high suspension mounts filled with silicone oil reduce heavy vibration. The long stroke achieved by this system provides excellent protection from vibration.

Twice the stroke of a conventional mount

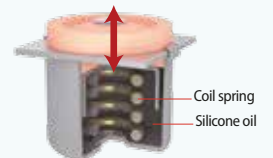

Broad View Liberates the Operator

The front window features one large piece of glass without a centre pillar on the right side for a wide, unobstructed view.

Air Conditioner NEW Register behind the Seat



The large air-conditioner has registers on the back pillars that blow from behind and to the right and left of the operator's seat. They can be adjusted to put a direct flow of cool/warm air on the operator, which means a more comfortable operating environment.

More Comfortable Seat Means Higher Productivity



Seat suspension absorbs vibration



Seat recliner can be pushed back flat



Double slides allow adjustment for optimum comfort



Large Cab Is Easy to Get In and Out of

The expanded cab provides plenty of room for a large door, more headroom and smoother entry and exit.

Interior Equipment Adds to Comfort and Convenience



Bluetooth installed AM/FM stereo radio



USB/AUX/12V power outlet

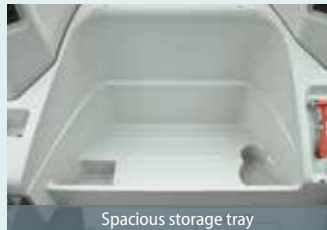

Spacious storage tray



Large cup holder

Safety



Mounting brackets for vandalism guards are standard equipment (contact your KOBELCO dealer to fit vandalism or front rock guards).



TOP Guard is fitted as standard.
*Working lights are optional.

Expanded Field of View for Greater Safety



Rear view camera

Right side view camera

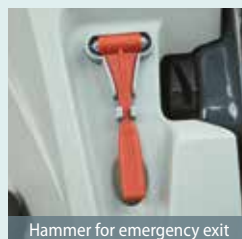

Hammer for emergency exit

Right Side Camera Fitted as Standard

In addition to the existing rear-view camera, a camera for the right side is fitted as standard for easy safety checks all around the machine.

Efficient Maintenance Keeps the Machine in Peak Operating Condition

Easy Maintenance That Supports Large-Scale Operation

Bolted Double Service Doors Open and Close Easily

- Intercooler • A/C condenser
- Fuel cooler • Radiator • Oil cooler



Air cleaner



Refueling pump



Auto-Coil Grease Gun Holder

- Grease tank
- Lubrication hose



DEF/AdBlue® tank*

Located inside the standard machine storage compartment

* AdBlue® is a registered trade mark of the Verband der Automobilindustrie e. V. (VDA).



Battery



Battery disconnect switch



Simple Filtration

Hydraulic oil filter x 3



Suction filter

Around the Engine Compartment



Fuel filter



Fuel pre-filter with water separator



Engine oil drain valve



Engine oil filter



Drain filter



Large tool box



Cat walk

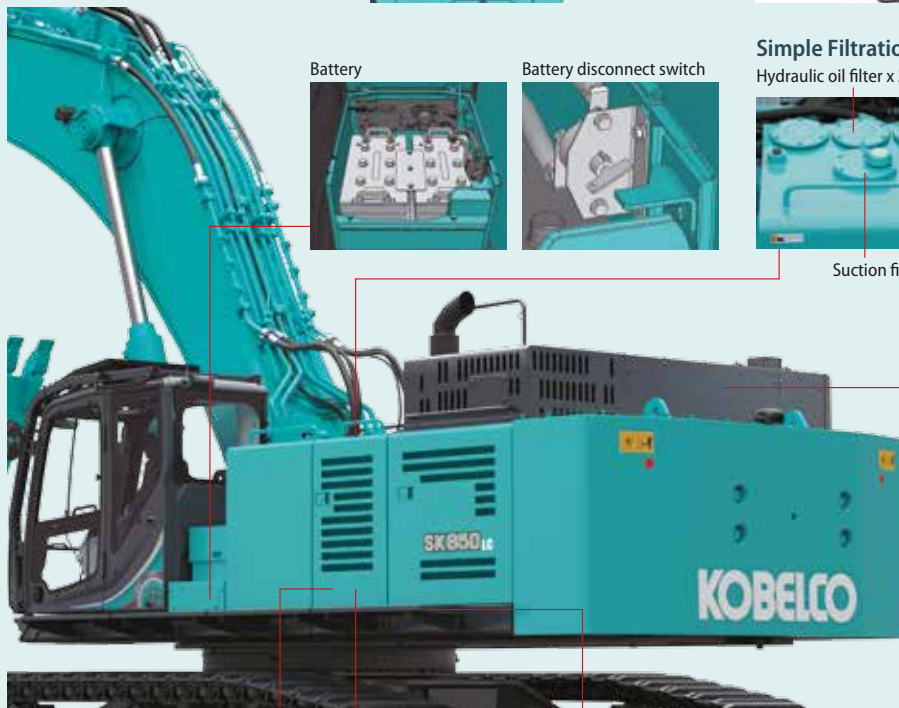

Daily maintenance checks are essential for the successful operation of large, continuously operating excavators. Inspections and maintenance must be quick and easy to maximize productivity. With its maintenance walk, the SK850LC provides easy access to essential components and systems so that more time is spent on the job.



Easy Inspection of Swing Bearing, Gear and Bolt

A small access port is located in front of the upper frame to make it easier to inspect the swing bearing, gear and bolt.

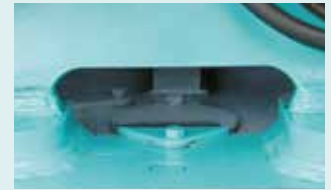

Easy Access to In-cab Maintenance Features



Easy-access fuse box.



DPF Manual Regeneration Switch



Air conditioner filter can be easily removed without tools for cleaning. One for outside air and one for inside air.

Easy Cleaning



Special sloped crawler side frame design is easily cleaned of mud.



Detachable two-piece floor mat with handles for easy removal.



Fuel tank features bottom flange and large drain valve for easy maintenance.

Total Support for Machines with Network Speed and Accuracy

KOMEXS is a satellite-based system for receiving machine information. Manage your machines anywhere in the world using the Internet. Location, workload and diagnostic data aid business operations.



Direct Access to Operational Status

Location Data

Accurate location data can be obtained even from sites where communications are difficult.

Operating Hours

A comparison of operating times of machines at multiple locations shows which locations are busier and more profitable. Operating hours on site can be accurately recorded, for running time calculations needed for rental machines, etc.

Fuel Consumption Data

Data on fuel consumption and idling times can be used to indicate improvements in fuel consumption.

Graph of Work Content

The graph shows how working hours are divided among different operating categories, including digging, idling, traveling, and optional operations (N&B).



Maintenance Data and Warning Alerts

Machine Maintenance Data

Provides maintenance status of separate machines operating at multiple sites. Maintenance data is also relayed to KOBELCO service personnel, for more efficient planning of periodic servicing.

Security System

Engine Start Alarm

Sends a notification if the engine is started outside of pre-defined hours.

Area Alarm

Sends a notification if the machine leaves a pre-defined area.



Engine

Model	HINO E13CYM-KSDB
Type	Water-cooled, 4cycle 6cylinder electronically-controlled common rail system type diesel engine with turbo-charger Complies with EU Stage V exhaust emission regulation.
No. of cylinders	6
Bore and stroke	137 mm × 146 mm
Displacement	13 L
Rated power output	Net 380 kW / 1,800 min ⁻¹ (ISO 14396 : without fan)
Max. torque	Net 2,120 N.m / 1,300 min ⁻¹ (ISO 14396 : without fan)



Hydraulic System

Pump	
Type	Two variable displacement pumps + One gear pump
Max. discharge flow	2 × 504 L/min, 1 × 30 L/min
Relief valve setting	
Excavating circuits (main)	33.0 Mpa
Travel circuit	33.0 Mpa
Swing circuit	25.9 Mpa
Pilot control circuit	5.0 Mpa
Pilot control pump	Gear type
Main control valve	6-spool
Oil cooler	Air cooled type



Swing System

Swing motor	Axial piston motor	
Parking brake	Oil disk brake, hydraulic operated automatically	
Swing speed	7.3 min ⁻¹	
Swing torque	268 kN·m	
Tail swing radius	4,580 mm	
Min front swing radius	3.6 m arm	6,340 mm
	ME	5,470 mm

Operating Weight & Ground Pressure

In standard trim, with HD 8.25 m boom, HD 3.6 m arm, 3.5 m³ ISO heaped bucket and standard counterweight

Shaped		Double grouser shoes (even height)			
Shoe width		mm	650	750	900
Overall width of crawler		mm	4,200(3,400)	4,300(3,500)	4,450(3,800)
Ground pressure	Without Full track guide	kPa	109	95	80
	With Full track guide	kPa	111	97	82
Operating weight	Without Full track guide	kg	80,200	80,800	82,000
	With Full track guide	kg	81,700	82,400	83,500

In standard trim, with 7.25 m ME boom, HD 2.9 m arm, 5.4 m³ ISO heaped bucket and Standard counterweight

Shaped		Double grouser shoes (even height)			
Shoe width		mm	650	750	900
Overall width of crawler		mm	4,200(3,400)	4,300(3,500)	4,450(3,800)
Ground pressure	Without Full track guide	kPa	109	95	80
	With Full track guide	kPa	111	97	82
Operating weight	Without Full track guide	kg	80,200	80,900	82,000
	With Full track guide	kg	81,800	82,400	83,600



Travel System

Travel motors	2 × axial-piston, two-step motors
Travel brakes	Hydraulic brake per motor
Parking brakes	Oil disk brake per motor
Travel shoes	51 each side
Travel speed (high/low)	4.2 / 2.7 km/h
Drawbar pulling force	653 kN
Gradeability	70 % (35 deg)
Ground clearance	850 mm



Cab & Control

Cab	
All-weather, sound-suppressed steel cab mounted on the high suspension mounts filled with silicone oil and equipped with a heavy, insulated floor mat.	
Control	
Two hand levers or two foot pedals for forward and backward operations of each track independently.	
Noise levels	
External	108 dB(A) (ISO 6395)
Operator	71 dB(A) (ISO 6396)



Boom, Arm & Bucket

Boom cylinders	210 mm × 1,800 mm
Arm cylinder	220 mm × 2,175 mm
Bucket cylinder	200 mm × 1,570 mm



Refilling Capacities & Lubrications

Fuel tank	960 L
Cooling system	74 L
Engine oil	54 L
Travel reduction gear	2 × 22 L
Swing reduction gear	2 × 21.5 L
Hydraulic oil tank	522 L tank oil level
	856 L hydraulic system
DEF/Urea tank	83 L

In standard trim, with HD 8.25 m boom, HD 3.6 m arm, 3.5 m³ ISO heaped bucket and Heavy counterweight (+3tons)

Shaped		Double grouser shoes (even height)			
Shoe width		mm	650	750	900
Overall width of crawler		mm	4,200(3,400)	4,300(3,500)	4,450(3,800)
Ground pressure	Without Full track guide	kPa	113	98	83
	With Full track guide	kPa	115	100	85
Operating weight	Without Full track guide	kg	83,200	83,800	85,000
	With Full track guide	kg	84,700	85,400	86,500

In standard trim, with 7.25 m ME boom, HD 2.9 m arm, 5.4 m³ ISO heaped bucket and Heavy counterweight (+3tons)

Shaped		Double grouser shoes (even height)			
Shoe width		mm	650	750	900
Overall width of crawler		mm	4,200(3,400)	4,300(3,500)	4,450(3,800)
Ground pressure	Without Full track guide	kPa	113	98	83
	With Full track guide	kPa	115	100	85
Operating weight	Without Full track guide	kg	83,200	83,900	85,000
	With Full track guide	kg	84,800	85,400	86,600

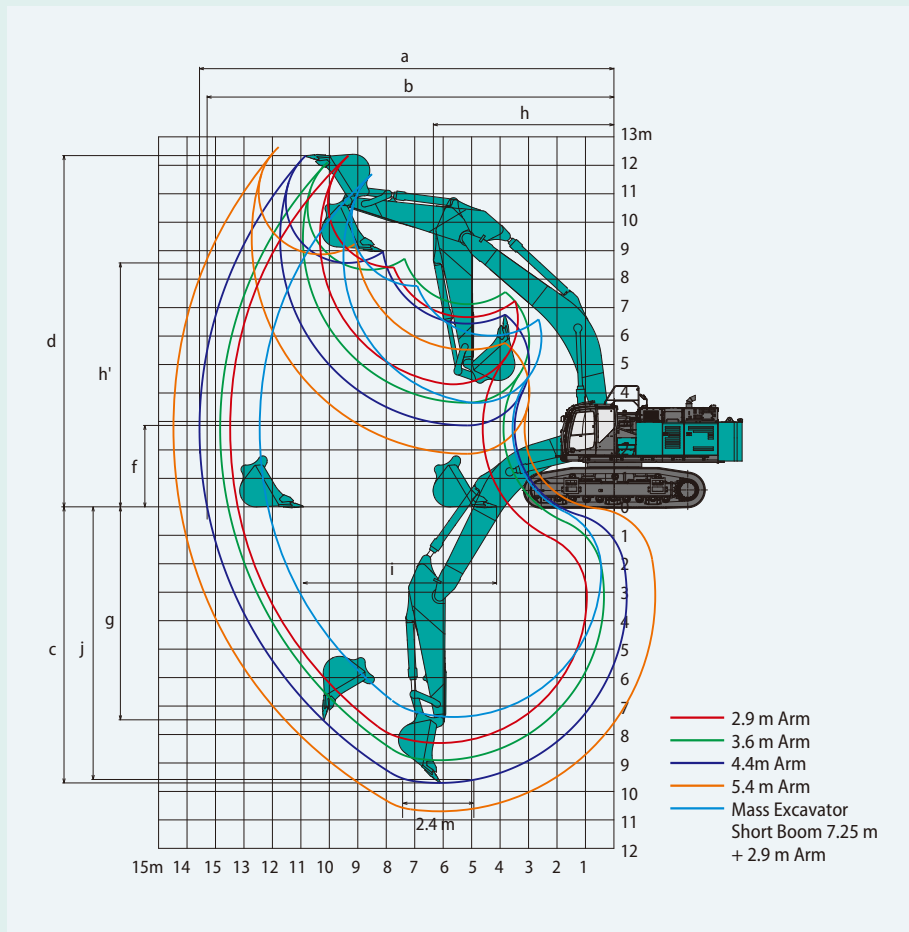

Working Ranges

Unit: m

Boom		8.25 m				7.25 m
Arm		2.9 m	3.6 m	4.4 m	5.4 m	2.9 m
Range						
a- Max. digging reach		13.48	13.83	14.56	15.48	12.45
b- Max. digging reach at ground level		13.19	13.55	14.29	15.23	12.13
c- Max. digging depth		8.30	8.9	9.7	10.70	7.38
d- Max. digging height		12.34	12.11	12.35	12.64	11.69
e- Max. dumping clearance		8.41	8.34	8.57	8.87	7.77
f- Min. dumping clearance		4.31	3.67	2.86	1.86	3.66
g- Max. vertical wall digging depth		5.16	6.74	7.48	8.41	4.42
h- Min. swing radius		5.74	6.34	6.34	6.39	5.47
i- Horizontal digging stroke at ground level		4.36	5.67	6.80	8.08	4.37
j- Digging depth for 2.4 m (8') flat bottom		8.15	8.75	9.58	10.60	7.23
Bucket capacity SAE heaped m ³		4.6	3.5	2.8	2.3	5.4

Digging Force (ISO 6015)

Unit: kN

Boom		8.25 m				7.25 m
Arm length		2.9 m	3.6 m	4.4 m	5.4 m	2.9 m
Bucket digging force	ISO	432	403	403	403	432
Arm crowding force	ISO	351	311	272	234	351

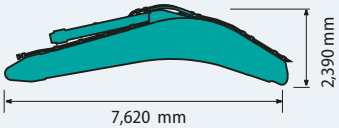
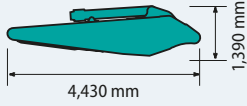
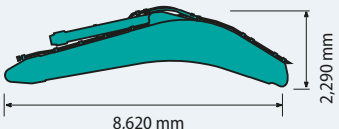
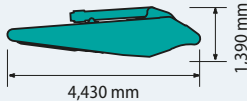
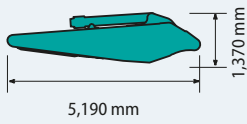
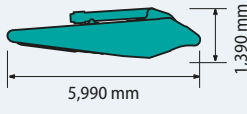
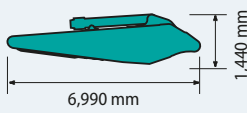

Attachments

Boom	Arm
7.25 m ME Boom Weight: 8,060 kg 	2.9 m Weight: 4,070 kg 
8.25 m Standard Boom Weight: 8,440 kg 	2.9 m Weight: 4,070 kg 
	3.6 m Weight: 4,180 kg 
	4.4 m Weight: 4,660 kg 
	5.4 m Weight: 5,300 kg 

Use		Backhoe bucket					
Bucket capacity	ISO heaped	m ³	2.3	2.8	3.5	4.6	5.4
	Struck	m ³	1.8	2.1	2.6	3.4	4.0
Opening width	With side cutter	mm	1,470	1,680	2,000	2,200	2,500
	Without side cutter	mm	1,370	1,580	1,900	2,100	2,400
No. of bucket teeth			4	5	5	6	6
Weight		kg	2,130	2,370	2,610	3,270	3,570
Combination	2.9 m short arm		○	○	○	◎	△
	3.6 m standard arm		○	○	◎	△	-
	4.4 m long arm		○	◎	△	-	-
	5.4 m long arm		◎	△	-	-	-
	2.9 m short arm + 7.25 m ME boom		-	-	-	-	◎

◎ Standard ○ Recommended △ Loading only

Dimensions

Boom		8.25 m				7.25 m
Arm length		2.9 m	3.6 m	4.4 m	5.4 m	2.9 m
A	Overall length	14,600	14,530	14,480	14,220	13,590
B	Overall height (to top of boom)	4,580	4,760	5,160	5,750	4,880
C	Overall width	Extended				4,440
		Retracted				3,400
D	Overall height (to top of cab)					3,770
E	Ground clearance of rear end*					1,560
F	Ground clearance*					850
G	Tail swing radius					4,580
G'	Distance from centre of swing to rear end					4,480
H	Tumbler distance					5,140
I	Overall length of crawler					6,380
J	Track gauge	Extended				3,550
		Retracted				2,750
K	Shoe Width					650
L	Overall width of upperstructure					4,170**
M	Overall length of upperstructure					6,350***

Unit: mm

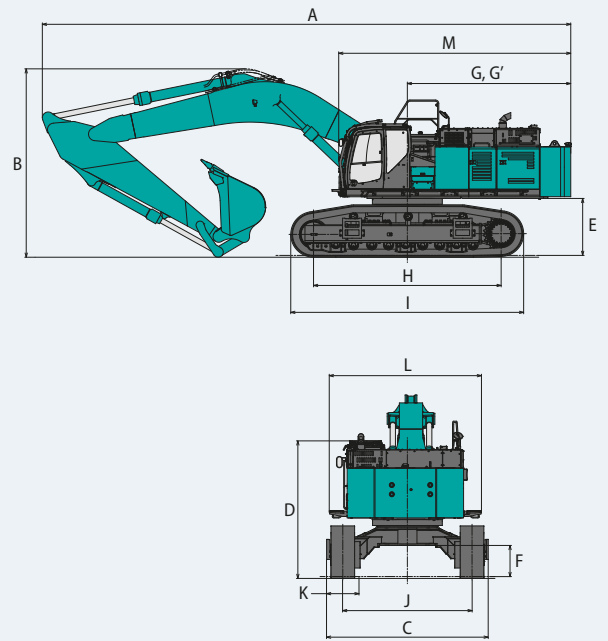

* Without including height of shoe lug **With catwalk ***With cab guard

Four Disassembly and Transport Patterns

The SK850LC can be disassembled and transported in four different ways, including: no counterweight, with boom attached; main body only; main body without crawler frame; etc.

Variable Gauge Crawler

The variable gauge crawler extends the crawlers for extremely stable operation, and retracts them for easier transport.

Crawler Width

Shoe	650 mm
Extended	4,200 mm
Retracted	3,400 mm

Configuration	Description	Total weight
<p>Plan 1</p> <p>4,860 mm 13,900 mm Transportation width: 3,400 mm / 650 mm shoe</p>	Base machine without counterweight and bucket, with lower structure, 8.25 m boom and 3.6 m arm	64,210 kg
<p>Plan 2</p> <p>3,770 mm 12,180 mm Transportation width: 3,400 mm / 650 mm shoe</p>	Base machine without counterweight, bucket and arm, with lower structure and 8.25 m boom	59,740 kg
<p>Plan 3</p> <p>3,770 mm 7,050 mm Transportation width: 3,400 mm / 650 mm shoe</p>	Base machine with lower structure, without counterweight, bucket, arm and boom	48,820 kg
<p>Plan 4</p> <p>2,880 mm 5,910 mm Transportation width: 3,190 mm</p>	Base machine with carbody, without counterweight, bucket, bucket, arm, boom and lower structure	24,470 kg

Standard counterweight: 13,300 kg

Lifting Capacities

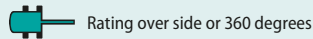
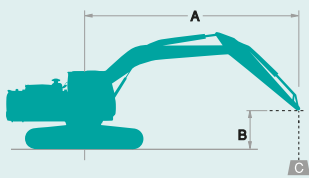

A: Reach from swing centreline to arm top
 B: Arm top height above/below ground
 C: Lifting capacities in Kilograms
 Bucket: Without bucket
 Relief valve setting: 33.0 MPa

SK850LC		Boom: 8.25 m		Arm: 3.60 m		Bucket: without		Shoe: 650 mm		Heavy counterweight: 16,300 kg							
B	A	3.0 m		4.5 m		6.0 m		7.5 m		9.0 m		10.5 m		At Max. Reach		Radius	
		Rating over front	Rating over side or 360 degrees	Rating over front	Rating over side or 360 degrees	Rating over front	Rating over side or 360 degrees	Rating over front	Rating over side or 360 degrees	Rating over front	Rating over side or 360 degrees	Rating over front	Rating over side or 360 degrees	Rating over front	Rating over side or 360 degrees		
10.5 m	kg														*14,590	*14,590	8.64 m
9.0 m	kg									*14,210	*14,210				*14,180	*14,180	9.81 m
7.5 m	kg											*14,680	*14,070	*14,070	*14,070	*14,070	10.64 m
6.0 m	kg								*17,750	*17,750	*15,650	*15,650	*14,420	*14,420	*14,120	*13,460	11.20 m
4.5 m	kg					*25,440	*25,440	*19,880	*19,880	*16,860	*16,860	*15,060	14,600	*14,290	12,590	11.53 m	
3.0 m	kg							*21,870	*21,870	*18,070	17,720	*15,750	14,190	*14,550	12,140	11.66 m	
1.5 m	kg						*30,480	30,200	*23,300	22,050	*19,040	17,150	*16,320	13,850	*14,870	12,050	11.58 m
G.L.	kg						*30,750	29,780	*23,980	21,570	*19,580	16,780	*16,580	13,620	*15,240	12,330	11.31 m
-1.5 m	kg			*23,780	*23,780	*29,990	29,760	*23,840	21,400	*19,520	16,630	*16,280	13,560	*15,630	13,060	10.81 m	
-3.0 m	kg	*25,800	*25,800	*35,480	*35,480	*28,270	*28,270	*22,790	21,500	*18,630	16,710			*15,980	14,480	10.06 m	
-4.5 m	kg	*38,460	*38,460	*31,330	*31,330	*25,320	*25,320	*20,510	*20,510	*16,170	*16,170			*16,160	*16,160	9.00 m	
-6.0 m	kg			*24,890	*24,890	*20,300	*20,300							*15,710	*15,710	7.47 m	

SK850LC		Boom: 8.25 m		Arm: 5.40 m		Bucket: without		Shoe: 650 mm		Heavy counterweight: 16,300 kg										
B	A	1.5 m		3.0 m		4.5 m		6.0 m		7.5 m		9.0 m		10.5 m		12.0 m		At Max. Reach		Radius
		Rating over front	Rating over side or 360 degrees	Rating over front	Rating over side or 360 degrees	Rating over front	Rating over side or 360 degrees	Rating over front	Rating over side or 360 degrees	Rating over front	Rating over side or 360 degrees	Rating over front	Rating over side or 360 degrees	Rating over front	Rating over side or 360 degrees	Rating over front	Rating over side or 360 degrees			
10.5 m	kg												*10,360	*10,360				*9,230	*9,230	10.77 m
9.0 m	kg																	*8,900	*8,900	11.73 m
7.5 m	kg													*11,110	*11,110	*10,820	*10,820	*8,790	*8,790	12.42 m
6.0 m	kg													*11,770	*11,770	*11,270	*11,270	*8,840	*8,840	12.90 m
4.5 m	kg									*16,100	*16,100	*14,000	*14,000	*12,650	*12,650	*11,770	*11,770	*9,060	*9,060	13.19 m
3.0 m	kg							*23,680	*23,680	*18,480	*18,480	*15,500	*15,500	*13,610	*13,610	*12,360	11,470	*9,440	*9,440	13.30 m
1.5 m	kg							*26,940	*26,940	*20,590	*20,590	*16,890	*16,890	*14,520	13,650	*12,920	11,130	*10,020	9,530	13.24 m
G.L.	kg					*17,680	*17,680	*28,940	*28,940	*22,120	21,370	*17,970	16,490	*15,250	13,210	*13,330	10,870	*10,860	9,650	13.00 m
-1.5 m	kg			*13,440	*13,440	*22,000	*22,000	*29,710	28,930	*22,950	20,810	*18,620	16,060	*15,660	12,920	*13,460	10,700	*12,090	10,030	12.57 m
-3.0 m	kg	*15,680	*15,680	*19,330	*19,330	*28,250	*28,250	*29,400	28,750	*23,000	20,570	*18,700	15,860	*15,600	12,800			*13,120	10,770	11.94 m
-4.5 m	kg	*21,490	*21,490	*26,200	*26,200	*36,720	*36,720	*28,040	*28,040	*22,170	20,620	*18,020	15,900	*14,750	12,900			*13,550	12,070	11.06 m
-6.0 m	kg			*34,870	*34,870	*32,910	*32,910	*25,370	*25,370	*20,180	*20,180	*16,150	*16,150					*13,920	*13,920	9.87 m
-7.5 m	kg					*26,540	*26,540	*20,740	*20,740	*16,160	*16,160							*13,970	*13,970	8.23 m

SK850LC		Boom: 7.25 m		Arm: 2.90 m		Bucket: without		Shoe: 650 mm		Heavy counterweight: 16,300 kg										
B	A	3.0 m		4.5 m		6.0 m		7.5 m		9.0 m		At Max. Reach		Radius						
		Rating over front	Rating over side or 360 degrees	Rating over front	Rating over side or 360 degrees	Rating over front	Rating over side or 360 degrees	Rating over front	Rating over side or 360 degrees	Rating over front	Rating over side or 360 degrees	Rating over front	Rating over side or 360 degrees							
9.0 m	kg													*18,890	*18,890	7.97 m				
7.5 m	kg									*19,060	*19,060				*18,320	*18,320	8.98 m			
6.0 m	kg						*23,900	*23,900	*20,390	*20,390	*18,500	*18,500	*18,130	17,390	*18,130	17,390	9.64 m			
4.5 m	kg						*27,550	*27,550	*22,210	*22,210	*19,320	18,960	*18,160	16,090	*18,160	16,090	10.02 m			
3.0 m	kg						*30,720	*30,720	*23,980	23,890	*20,210	18,450	*18,310	15,480	*18,310	15,480	10.17 m			
1.5 m	kg						*32,340	31,890	*25,170	23,200	*20,830	18,040	*18,540	15,440	*18,540	15,440	10.09 m			
G.L.	kg						*32,300	31,490	*25,440	22,830	*20,820	17,820	*18,780	16,020	*18,780	16,020	9.77 m			
-1.5 m	kg																	*38,170	*38,170	9.18 m
-3.0 m	kg	*39,250	*39,250	*34,420	*34,420	*27,630	*27,630	*21,870	*21,870						*18,720	*18,720	8.28 m			
-4.5 m	kg			*26,970	*26,970	*21,570	*21,570								*17,470	*17,470	6.94 m			

SK850LC		Boom: 7.25 m		Arm: 2.90 m		Bucket: without		Shoe: 900 mm		Heavy counterweight: 16,300 kg										
B	A	3.0 m		4.5 m		6.0 m		7.5 m		9.0 m		At Max. Reach		Radius						
		Rating over front	Rating over side or 360 degrees	Rating over front	Rating over side or 360 degrees	Rating over front	Rating over side or 360 degrees	Rating over front	Rating over side or 360 degrees	Rating over front	Rating over side or 360 degrees	Rating over front	Rating over side or 360 degrees							
9.0 m	kg													*18,890	*18,890	7.97 m				
7.5 m	kg									*19,060	*19,060				*18,320	*18,320	8.98 m			
6.0 m	kg						*23,900	*23,900	*20,390	*20,390	*18,500	*18,500	*18,130	17,730	*18,130	17,730	9.64 m			
4.5 m	kg						*27,550	*27,550	*22,210	*22,210	*19,320	*19,320	*18,160	16,400	*18,160	16,400	10.02 m			
3.0 m	kg						*30,720	*30,720	*23,980	23,980	*20,210	18,810	*18,310	15,790	*18,310	15,790	10.17 m			
1.5 m	kg						*32,340	*32,340	*25,170	23,660	*20,830	18,400	*18,540	15,760	*18,540	15,760	10.09 m			
G.L.	kg						*32,300	32,120	*25,440	23,290	*20,820	18,180	*18,780	16,350	*18,780	16,350	9.77 m			
-1.5 m	kg																	*38,170	*38,170	9.18 m
-3.0 m	kg	*39,250	*39,250	*34,420	*34,420	*27,630	*27,630	*21,870	*21,870						*18,720	*18,720	8.28 m			
-4.5 m	kg			*26,970	*26,970	*21,570	*21,570								*17,470	*17,470	6.94 m			

SK850LC		Boom: 8.25 m Arm: 3.60 m Bucket: without Shoe: 650 mm Standard counterweight: 13,300 kg															
B \ A	3.0 m		4.5 m		6.0 m		7.5 m		9.0 m		10.5 m		At Max. Reach		Radius		
10.5 m	kg														*14,590	*14,590	8.64 m
9.0 m	kg									*14,210	*14,210				*14,180	*14,180	9.81 m
7.5 m	kg									*14,680	*14,680	*14,070	13,710	*14,070	13,370	10.64 m	
6.0 m	kg							*17,750	*17,750	*15,650	*15,650	*14,420	13,440	*14,120	12,020	11.20 m	
4.5 m	kg					*25,440	*25,440	*19,880	*19,880	*16,860	16,520	*15,060	13,040	*14,290	11,200	11.53 m	
3.0 m	kg							*21,870	20,500	*18,070	15,820	*15,750	12,630	*14,550	10,760	11.66 m	
1.5 m	kg					*30,480	26,920	*23,300	19,650	*19,040	15,260	*16,320	12,280	*14,870	10,660	11.58 m	
G.L.	kg					*30,750	26,510	*23,980	19,170	*19,580	14,890	*16,580	12,060	*15,240	10,900	11.31 m	
-1.5 m	kg			*23,780	*23,780	*29,990	26,480	*23,840	19,000	*19,520	14,740	*16,280	12,000	*15,630	11,560	10.81 m	
-3.0 m	kg	*25,800	*25,800	*35,480	*35,480	*28,270	26,730	*22,790	19,100	*18,630	14,820			*15,980	12,830	10.06 m	
-4.5 m	kg	*38,460	*38,460	*31,330	*31,330	*25,320	*25,320	*20,510	19,490	*16,170	15,250			*16,160	15,250	9.00 m	
-6.0 m	kg			*24,890	*24,890	*20,300	*20,300							*15,710	*15,710	7.47 m	

SK850LC		Boom: 8.25 m Arm: 5.40 m Bucket: without Shoe: 650 mm Standard counterweight: 13,300 kg																		
B \ A	1.5 m		3.0 m		4.5 m		6.0 m		7.5 m		9.0 m		10.5 m		12.0 m		At Max. Reach		Radius	
10.5 m	kg													*10,360	*10,360			*9,230	*9,230	10.77 m
9.0 m	kg																	*8,900	*8,900	11.73 m
7.5 m	kg													*11,110	*11,110	*10,820	*10,820	*8,790	*8,790	12.42 m
6.0 m	kg													*11,770	*11,770	*11,270	10,810	*8,840	*8,840	12.90 m
4.5 m	kg								*16,100	*16,100	*14,000	*14,000	*12,650	*12,650	*11,770	10,490	*9,060	8,810	13.19 m	
3.0 m	kg						*23,680	*23,680	*18,480	*18,480	*15,500	*15,500	*13,610	12,610	*12,360	10,140	*9,440	8,470	13.30 m	
1.5 m	kg						*26,940	*26,940	*20,590	19,900	*16,890	15,240	*14,520	12,080	*12,920	9,800	*10,020	8,350	13.24 m	
G.L.	kg				*17,680	*17,680	*28,940	26,300	*22,120	18,970	*17,970	14,600	*15,250	11,650	*13,330	9,540	*10,860	8,440	13.00 m	
-1.5 m	kg			*13,440	*13,440	*22,000	*22,000	*29,710	25,660	*22,950	18,410	*18,620	14,170	*15,660	11,360	*13,460	9,370	*12,090	8,770	12.57 m
-3.0 m	kg	*15,680	*15,680	*19,330	*19,330	*28,250	*28,250	*29,400	25,470	*23,000	18,170	*18,700	13,970	*15,600	11,240			*13,120	9,440	11.94 m
-4.5 m	kg	*21,490	*21,490	*26,200	*26,200	*36,720	*36,720	*28,040	25,640	*22,170	18,220	*18,020	14,010	*14,750	11,340			*13,550	10,600	11.06 m
-6.0 m	kg			*34,870	*34,870	*32,910	*32,910	*25,370	*25,370	*20,180	18,570	*16,150	14,330					*13,920	12,700	9.87 m
-7.5 m	kg					*26,540	*26,540	*20,740	*20,740	*16,160	*16,160							*13,970	*13,970	8.23 m

SK850LC		Boom: 7.25 m Arm: 2.90 m Bucket: without Shoe: 650 mm Standard counterweight: 13,300 kg													
B \ A	3.0 m		4.5 m		6.0 m		7.5 m		9.0 m		At Max. Reach		Radius		
9.0 m	kg							*18,820	*18,820			*18,890	*18,890	7.97 m	
7.5 m	kg							*19,060	*19,060			*18,320	17,860	8.98 m	
6.0 m	kg					*23,900	*23,900	*20,390	*20,390	*18,500	17,550	*18,130	15,660	9.64 m	
4.5 m	kg					*27,550	*27,550	*22,210	*22,210	*19,320	17,070	*18,160	14,430	10.02 m	
3.0 m	kg					*30,720	29,610	*23,980	21,490	*20,210	16,560	*18,310	13,850	10.17 m	
1.5 m	kg					*32,340	28,610	*25,170	20,800	*20,830	16,150	*18,540	13,800	10.09 m	
G.L.	kg					*32,300	28,210	*25,440	20,430	*20,820	15,930	*18,780	14,310	9.77 m	
-1.5 m	kg			*38,170	*38,170	*30,800	28,230	*24,540	20,370	*19,600	15,980	*18,920	15,580	9.18 m	
-3.0 m	kg	*39,250	*39,250	*34,420	*34,420	*27,630	*27,630	*21,870	20,670			*18,720	18,170	8.28 m	
-4.5 m	kg			*26,970	*26,970	*21,570	*21,570					*17,470	*17,470	6.94 m	

SK850LC		Boom: 7.25 m Arm: 2.90 m Bucket: without Shoe: 900 mm Standard counterweight: 13,300 kg													
B \ A	3.0 m		4.5 m		6.0 m		7.5 m		9.0 m		At Max. Reach		Radius		
9.0 m	kg							*18,820	*18,820			*18,890	*18,890	7.97 m	
7.5 m	kg							*19,060	*19,060			*18,320	18,220	8.98 m	
6.0 m	kg					*23,900	*23,900	*20,390	*20,390	*18,500	17,910	*18,130	15,990	9.64 m	
4.5 m	kg					*27,550	*27,550	*22,210	*22,210	*19,320	17,430	*18,160	14,750	10.02 m	
3.0 m	kg					*30,720	30,240	*23,980	21,950	*20,210	16,920	*18,310	14,160	10.17 m	
1.5 m	kg					*32,340	29,240	*25,170	21,260	*20,830	16,510	*18,540	14,120	10.09 m	
G.L.	kg					*32,300	28,840	*25,440	20,890	*20,820	16,290	*18,780	14,640	9.77 m	
-1.5 m	kg			*38,170	*38,170	*30,800	28,860	*24,540	20,830	*19,600	16,340	*18,920	15,930	9.18 m	
-3.0 m	kg	*39,250	*39,250	*34,420	*34,420	*27,630	*27,630	*21,870	21,130			*18,720	18,570	8.28 m	
-4.5 m	kg			*26,970	*26,970	*21,570	*21,570					*17,470	*17,470	6.94 m	

Notes:

- Do not attempt to lift or hold any load that is greater than these lift capacities at their specified lift point radius and heights. Weight of all accessories must be deducted from the above lift capacities.
- Lift capacities are based on machine standing on level, firm, and uniform ground. User must make allowance for job conditions such as soft or uneven ground, out of level conditions, side loads, sudden stopping of loads, hazardous conditions, experience of personnel, etc.
- Arm top defined as lift point.
- The above lifting capacities are in compliance with ISO 10567. They do not exceed 87% of hydraulic lifting capacity or 75% of tipping load. Lifting capacities marked with an asterisk (*) are limited by hydraulic capacity rather than tipping load.
- Operator should be fully acquainted with the Operator's and Maintenance Instructions before operating this machine. Rules for safe operation of equipment should be adhered to at all times.
- Lift capacities apply to only machine as originally manufactured and normally equipped by KOBELCO CONSTRUCTION MACHINERY CO., LTD.

STANDARD EQUIPMENT

ENGINE

- Engine, HINO E13CYM-KSDB, diesel engine with turbocharger and intercooler, EU Stage V compliant
- Auto idle stop (AIS)
- Automatic engine deceleration
- Batteries (2 x 12 V, 190H52)
- Starting motor (24 V -7 kW), 90 amp alternator
- Removable clean-out screen for radiator
- Automatic shut-down for low engine oil pressure
- Engine oil pan drain cook
- Double element air cleaner x 2
- Hydraulic driven cooling fan
- Refueling pump

CONTROL

- Working mode selector (H-mode, S-mode and ECO-mode)
- Object Handling Kit (boom and arm safety valve)
- Extra N&B piping (proportional hand control) without ME ver.
- Battery disconnect switch

SWING SYSTEM & TRAVEL SYSTEM

- Swing rebound prevention system
- Straight propel system
- Two-speed travel with automatic shift down
- Sealed & lubricated track links
- Grease-type track adjusters
- Automatic swing brake
- MVLC

HYDRAULIC

- Auto warm up system
- Aluminum hydraulic oil cooler
- Hydraulic fluid filter clog detector
- Quick hitch piping

MIRRORS, LIGHTS & CAMERAS

- Rearview mirror
- Four front working lights
- Rear & right side camera

CAB & CONTROL

- Two control levers, pilot-operated
- Horn, electric
- Cab light (interior)
- Luggage tray
- Large cup holder
- Detachable two-piece floor mat
- Headrest
- Handrails
- Intermittent windshield wiper with double-spray washer
- Skylight
- Tinted safety glass
- Pull-up type front window and removable lower front window
- Easy-to-read multi-display color monitor
- Automatic air conditioner
- Emergency escape hammer
- Air suspension seat with heater
- EU radio (AUX, USB, and Bluetooth)
- TOP guard (ISO 10262:1998)
- Remote machine monitoring system "KOMEXS"
- Tow eyes
- Cat walk (left and front of the right side)
- Lower frame guard (t=9mm)

OPTIONAL EQUIPMENT

- ME specification
- Various optional arms
- Wide range of shoes
- Full track guide
- Two cab lights
- Mechanical suspension seat (Optional for N&B piping specification)
- Heavier counterweight (+3,000 kg)
- Rain visor (may interfere with bucket action)
- Front Guard
- Travel alarm
- Hoisting kit

Note: Standard and optional equipment may vary. Consult your KOBELCO dealer for specifics.

Note: This catalogue may contain attachments and optional equipment that are not available in your area. And it may contain photographs of machines with specifications that differ from those of machines sold in your areas. Please consult your nearest KOBELCO distributor for those items you require. Specialist equipment is needed to use this machine in demolition work. Before using it please contact your KOBELCO dealer.

Due to our policy of continuous product improvements all designs and specifications are subject to change without advance notice.

Copyright by **KOBELCO CONSTRUCTION MACHINERY CO., LTD.** No part of this catalogue may be reproduced in any manner without notice.

KOBELCO CONSTRUCTION MACHINERY EUROPE B.V.

Veluwezoom 15
1327 AE Almere
The Netherlands
www.kobelco-europe.com

Enquiries To: